

OHE Fittings & PG Clamps



We Support



“Make In India”



★ **PPS International** ★

(www.ppsinternational.in)

IRISTM
Certified



OHE Fittings

PPS International is pioneer in manufacturing wide variety of OHE Fittings in different material, different sizes and with different manufacturing processes.

PG Clamp for Catenary and Jumper Wire



Compression Clamp

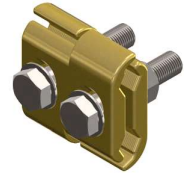

PG Clamp

PG Clamp for Contact and Jumper Wire



T-Clamp

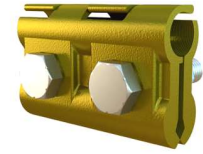

Bridging Clamp

Jumper Clamp

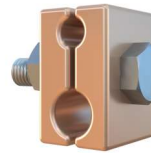

Cu Clamp for
12-26 mm²



Cu Clamp for
12-164 mm²

(Note:- Other sizes can be produced on request)

Contact Wire Clamp

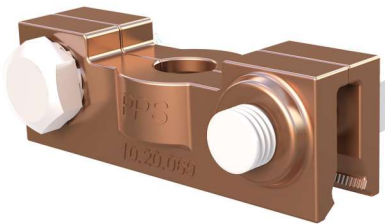

Current carrying Dropper



Jumper Clamp for Stay Tube

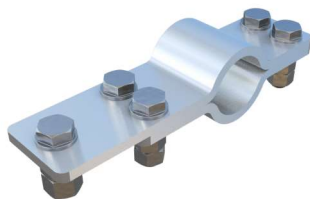

Anti Bird Disc

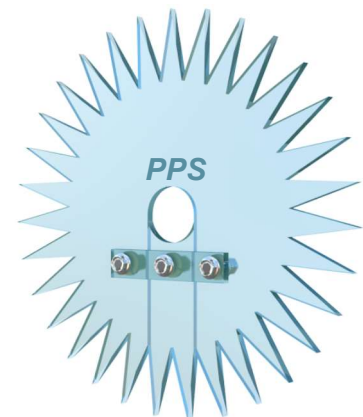

Compression Clamp

These Compression Clamps are made up of pure ETP Copper and produced for the specific size of catenary and jumper wire.

Various sizes are available as standard item, however specific sizes can also be produced against specific requirements.

S. No.	Part No.	Size of Catenary (mm ²)	Size of Jumper (mm ²)
1	400-000-18 (Small Size*)	65	26
2	400-000-019	65	26
3	400-000-033	65	50
4	400-000-021	65	164
5	400-000-024	120	26
6	400-000-034	120	50
7	400-000-029	120	164

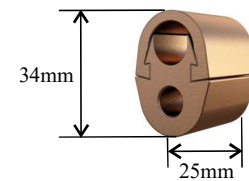
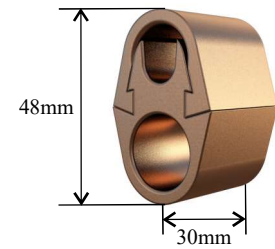

Small Size

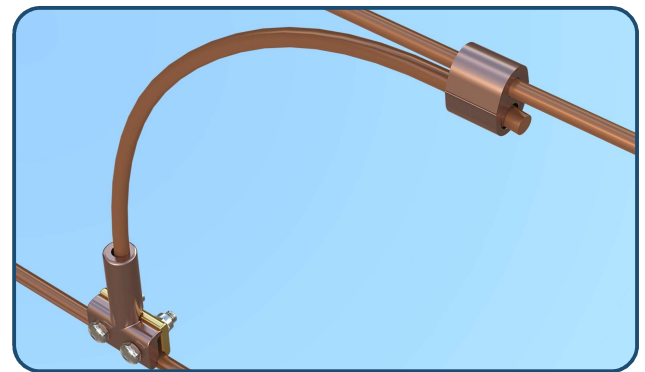
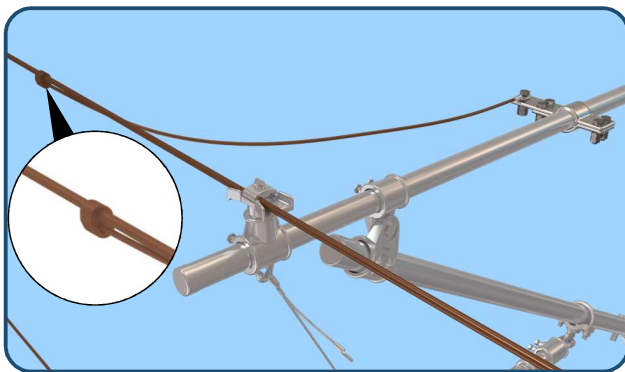

PG Clamp

These PG Clamps are produced through cold forging process using copper alloy and equipped with A4-80 stainless steel hardware.

These PG Clamps are specifically designed to connect different sizes of catenary and jumper wire from 35 to 300 mm². i.e. one size fits all and it is reusable type being bolted unlike compression clamp, which is only one time usable.

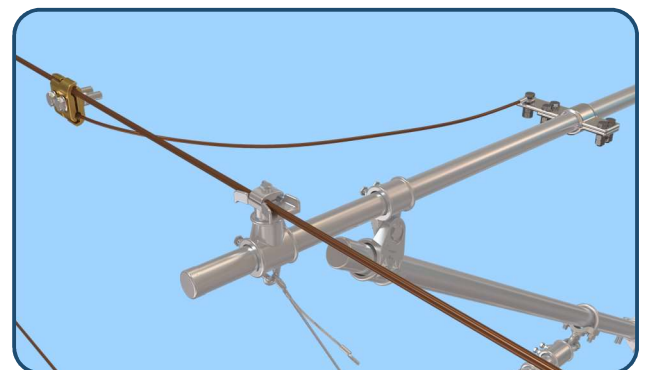
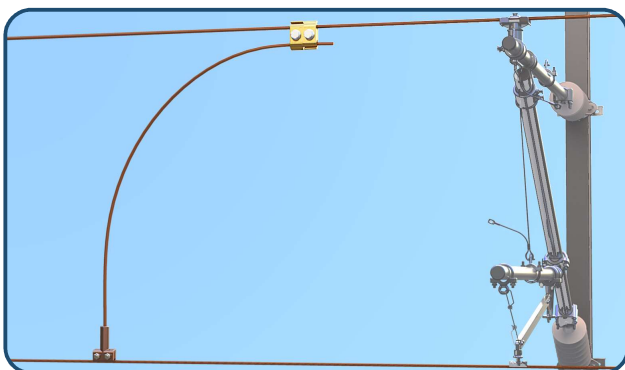



PG Clamp For Contact and Jumper Wire

T-Clamp

These T-Clamps are made up of pure ETP Copper through cold forging process and are specifically designed to connect different sizes of contact and jumper wires.

These T-Clamps are equipped with A4-80 stainless steel hardware.

Various sizes are available as standard item, however specific sizes can also be produced against specific requirements.

S. No.	Size of Jumper Wire (mm ²)	Size of Contact Wire (mm ²)
1	26	107/150
2	164	107/150

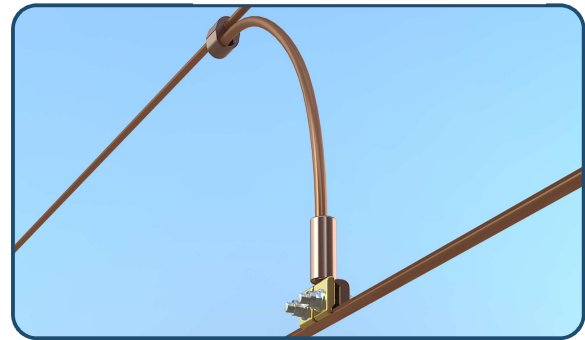
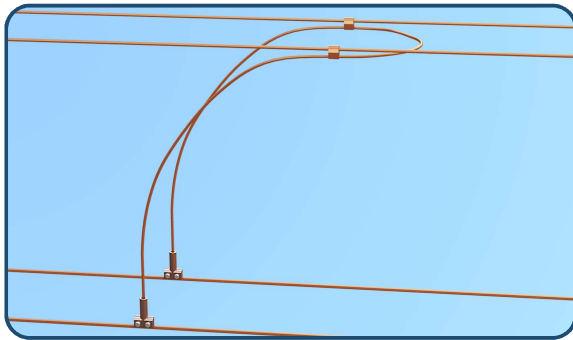
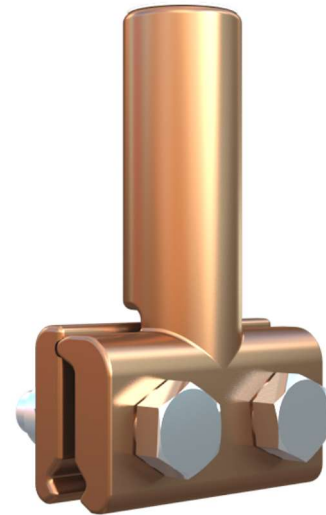

Bridging Clamp

These Bridging Clamps are produced through cold forging process using copper alloy (CuNi2Si) and connected with A4-80 stainless steel hardwares.

These Bridging Clamps are specifically designed to connect standard 107/150mm² contact wire and specific size of jumper wire. It is reusable type being bolted unlike T-Clamp in which jumper wire is crimped and is only one time usable.

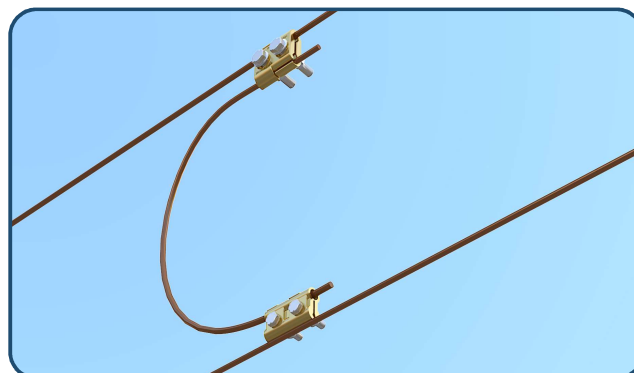
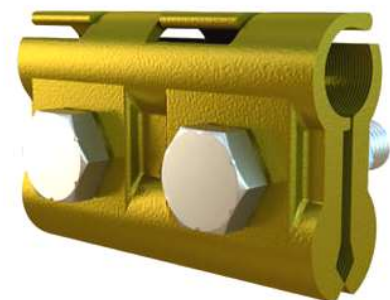

Jumper Clamp

Jumper Clamps are used to connect with dropper wire and works as a support while making the jumper connection.

One side size is equal to dropper wire size where as on the other side size is equivalent to jumper cable size.

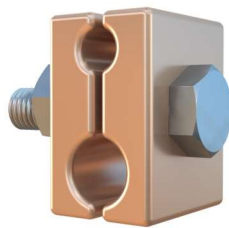
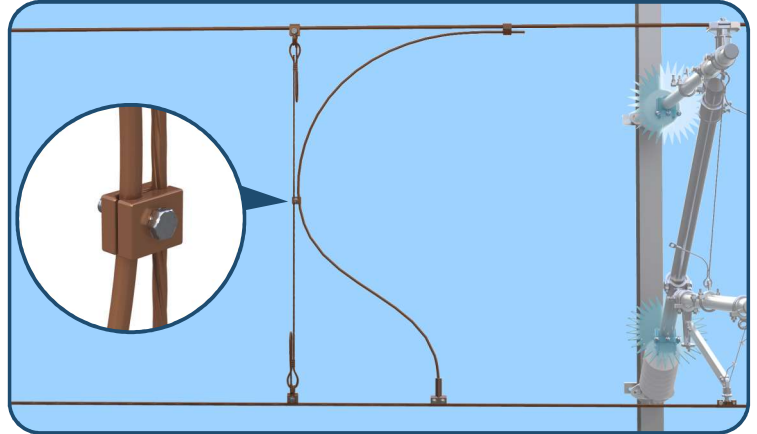

Cu Clamp for 12-26 mm²

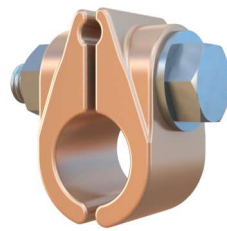

Cu Clamp for 12-164 mm²

Contact Wire Clamp

The Contact Wire Clamp is used to hold the contact wire with steady arm of the cantilever.

This part is specially designed and manufactured with a very high quality Copper Alloy i.e. CuNi2Si through cold forging process and equipped with A4-80 stainless steel hardware.

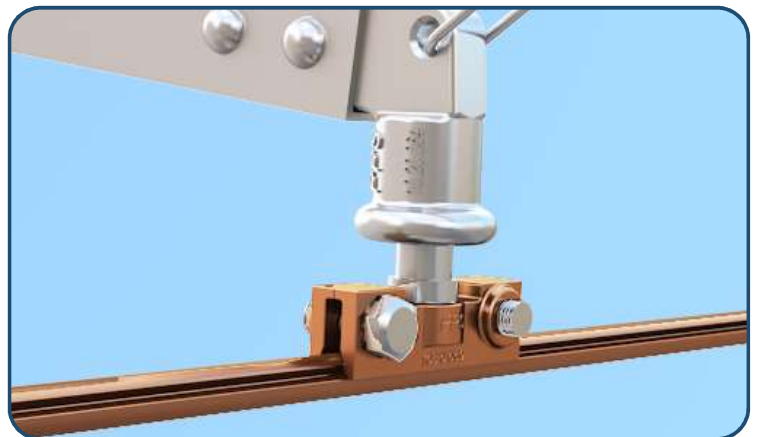
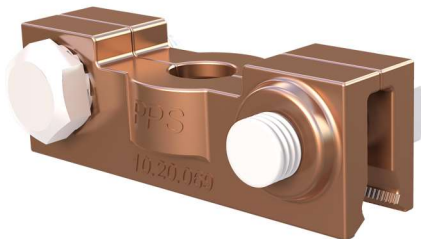

Jumper Stay Tube Clamp

S. No.	Part No.	Description	Size of Pipe (mm ²)
1	10.20.622	Jumper Clamp Stay Tube for G.I Pipe	38mm G.I.
2	10.20.624	Jumper Clamp Stay Tube for AL Pipe	55mm AL

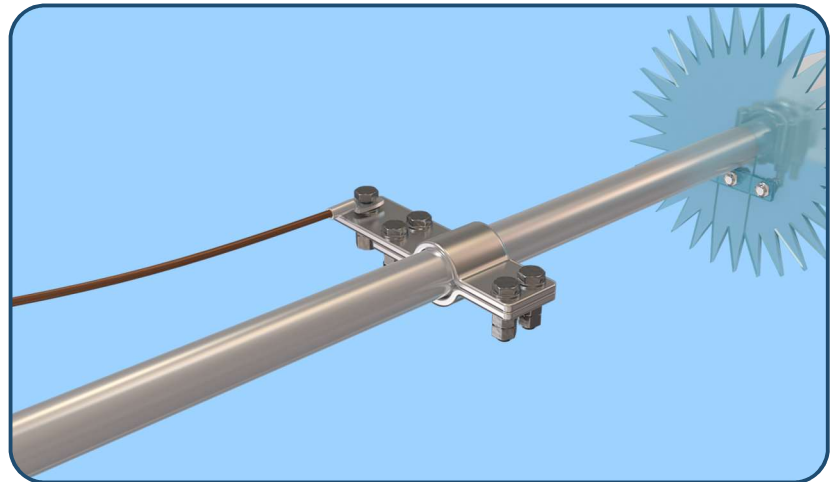
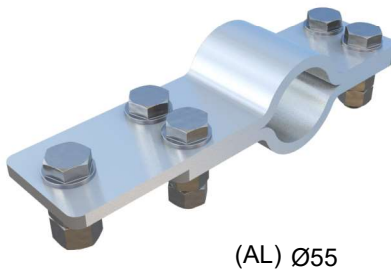
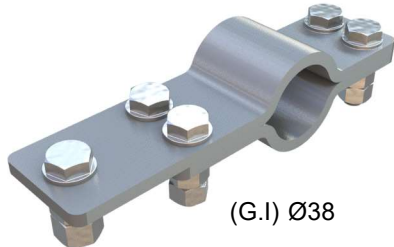

Anti Bird Disc

To avoid short circuiting though birds sitting on cantilever, thereby bridging of live parts to earth.

- Material:- Poly Carbonate

S. No.	Part No.	Description	Material
1	10.20.620	Anti-Bird Disk 47mm	Poly Carbonate
2	10.20.621	Anti-Bird Disk 54mm	Poly Carbonate

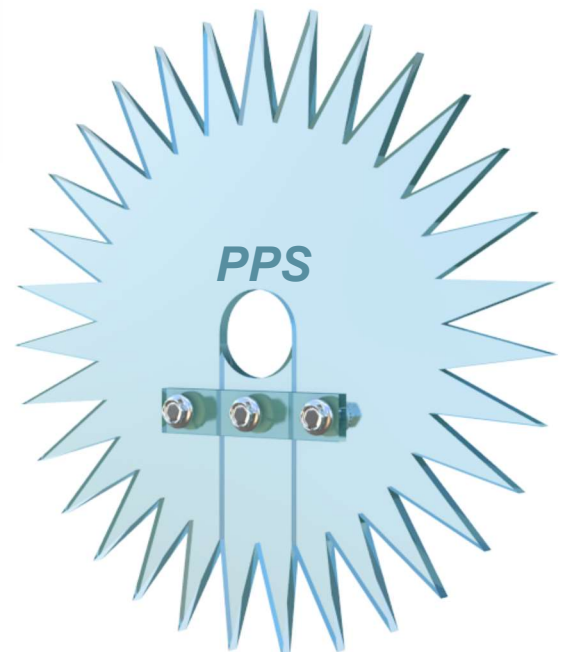
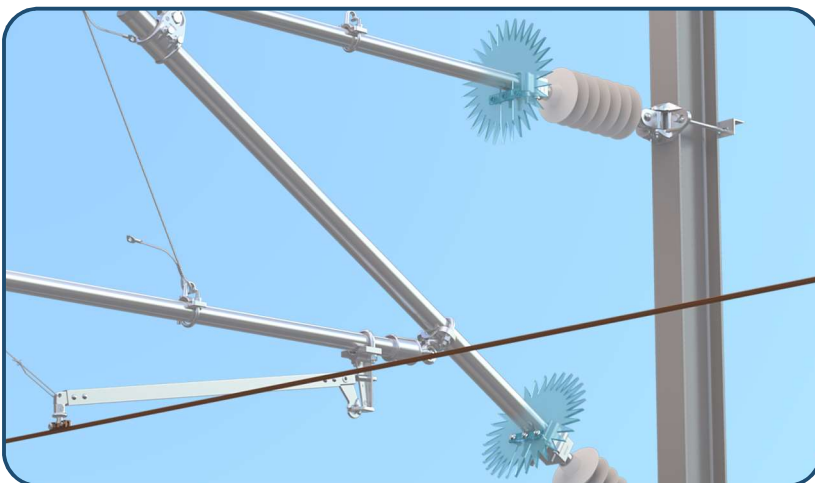

Current Carrying Dropper

PPS International is producing very high quality current carrying droppers used in OHE system.

Besides supplying only dropper parts (Fitting items), PPS International also supplies factory made complete dropper assembly together with 10 or 12 mm² CuMg (Bronze) dropper wires specially imported from Germany.

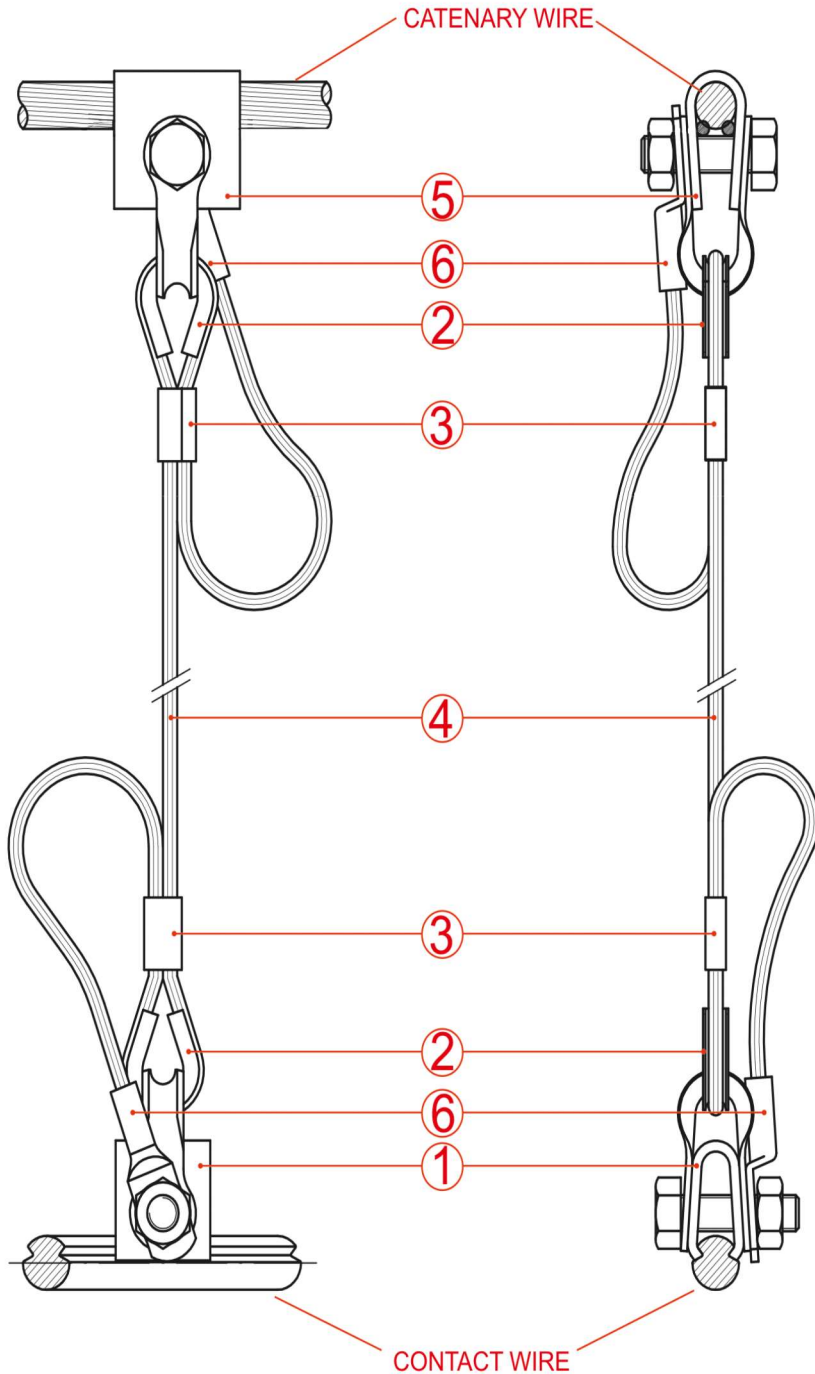

Current Carrying Dropper



1. Contact Wire Clamp Assembly



2. Thimble (Dropper Wire)

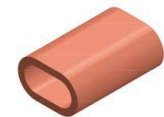

3. Sleeve (Dropper Wire)



4. Dropper Wire



5. Catenary Wire Clamp Assembly



6. Lug (Dropper Wire)



UNIT-1
Corporate Office



UNIT-2



PPS International

www.ppsinternational.in

Unit 1 Corporate Office :-
Plot No-32, Udyog kendra
Ecotech- III , Greater Noida
UP- 201306

Phone Number : +91-8800776682
Email : info@ppsinternational.in
Website : www.ppsinternational.in

Unit 2 :-
Plot No-85, Ecotech - XII
Greater Noida
UP- 201306

Revision:- 2
08/2022